

User Manual



LiFePO4 Battery System

In order to prevent improper operation before use, please carefully read this manual.

Contents

1. INTRODUCTION	1
2. SYMBOLS	1
3. SAFETY	2
3.1 Safety Rules	2
3.2 Safety Information	2
3.3 Installation	3
4. RESPONSE TO EMERGENCY SITUATIONS	3
4.1 Fire Situation	3
5. TRANSPORTATION	3
5.1 Regulations for the transport of battery modules	3
5.2 Permissible and Impermissible Storage Positions of a Packaged	4
6. STORAGE	4
7. PRODUCT INFORMATION	5
7.1 Battery Module Specifications	5
7.2 Labels	7
8. ELECTRICAL CONNECTIONS	8
8.1 Battery System Features	8
8.2 Battery system introduction	8
8.3 Electrical Interface Description of Control cabinet	9
8.4 Battery box introduction	9
8.5 Base introduction	10
8.6 Switch On / Off	10
9. INSTALLATION	10
9.1 Tools	10
9.2 Items in the package	11
9.3 Product size information	13
9.4 Floor installation with base	14
9.5 Install Environment	15
9.6 Installation Procedure	15
9.7 Wiring Procedure	17
9.8 Terminal Connection	17
9.9 System Wiring Schematic	18
9.10 Parallel DIP Switch	19
10. LCD DISPLAY ICONS	20
10.1 Main Interface	20
10.2 Fault Code Table	22
11. CONFIGURE NETWORK	23
11.1 Download APP	23
11.2 Connect to Built-in WIFI wireless network	23
11.3 Configure the network	23
11.4. Create the plant	24
12. WARRANTY	26
13. TROUBLESHOOTING AND MAINTENANCE	26
13.1 Maintenance	26
13.2 Troubleshooting	26

















1. INTRODUCTION

The document describes the installation, commissioning, maintenance and troubleshooting of the following high voltage battery listed below.

The battery chemistry of these products is Lithium Iron Phosphate. This manual is designed for qualified personnel only. The tasks described in this document should be performed by authorized and qualified technicians only.

After Installation the Installer must explain the user manual to the end user.

2. SYMBOLS

	Danger! Serious physical injury or even death may occur if not follow the relative requirements.		Install the product out of reach of children
	Caution, risk of electric shock.		Do not place nor install near flammable or explosive materials
	In case of electrolyte leakage, keep leaked electrolyte away from eyes or skin.		Disconnect the equipment before carrying out maintenance or repair
	Do not connect the Pack's positive(+) and negative(-)terminal reversely.		Societe Generale de Surveillance S.A.
	Observe precautions for handling electrostatic discharge sensitive devices.		Instruction manual: Read the instruction manual before starting installation and operation.
	Caution, risk of electric shock, energy storage timed discharge		CE mark: The inverter complies with the CE directive.
	Recyclable.	NOTE	Note: The procedures taken for ensuring proper operation.
	Do not use the Pack beyond specified conditions		Earth terminal The inverter must be reliably grounded.
	Take care! This Pack is heavy enough to cause serious injury.		EU WEEE mark: Product should not be disposed as household waste.

SPECIFICATIONS FOR FLH48100UG1

The battery system is mainly used insolar power system for family houselt also has a switch to control the battery easilyand timely protect our Household application

3. SAFETY

3.1 Safety rules

To avoid property damage and personal injury, the following rules shall be flowled when working on the hazardous live parts of the battery energy storage system:

- It is available for use.
- Ensure that it will not restart.
- Make sure there is no voltage.
- Grounding protection and short circuit protection.
- Cover or shield adjacent live parts.

3.2 Safety information

Part damage or short circuit may cause electric shock and death. A short circuit can be caused by connecting battery terminals, resulting in current flow, This type of short circuit shall be avoided under any circumstances, For this reason, follow these instructions:

- Use insulated tools and gloves.
- Do not place any tools or metal parts on the battery module or high-voltage control box.
- When operating the battery, be sure to remove watches, rings, and other metal objects.
- Do not install or operate this system in explosive or high-humidity areas.
- When working on the energy storage system, first turn off the charging controller, then the battery, and ensure that they are not turned on again.

Improper use of the battery energy storage system can lead to death. The use of the battery energy storage system beyond its intended use is not allowed, because it may cause great danger.

Improper handling of the battery energy storage system can cause life-threatening risks, serious injury or even death.



Warning! improper use can cause damage to the battery cell.

- Do not expose the battery module to rain or soak it in liquid.
- Do not expose the battery module to a corrosive environment (such as ammonia and salt).
- The battery energy storage system shall be debugged no later than six months after delivery.

3.3 Installation

- After unpacking, please check the product for damages and missing parts.
- Make sure that the inverter and battery is completely turned off before commencing installation.
- Do not interchange the positive and negative terminals of the battery.
- Ensure that there is no short circuit of the terminals or with any external device.
- Do not exceed the battery voltage rating of the inverter.
- Do not connect the battery to any incompatible inverter.
- Do not connect different battery types together.
- Please ensure that all the batteries are grounded properly.
- Do not open the battery to repair or disassemble.
- In case of fire, use only dry powder fire extinguisher.
- Install the battery away from children or pets.
- Do not use battery in high static environment where the protection device might be damaged.
- Do not install with other batteries or cells.

4. RESPONSE TO EMERGENCY SITUATIONS

The batteries comprise of multiple batteries connected in series. It is designed to prevent hazards or failures. However, Felicitysolar cannot guarantee their absolute safety. Under exposure to the internal materials of the battery the following recommendations should be carried out by the user.

- If there has been inhalation, please leave the contaminated area immediately and seek medical attention.
- If there has been contact with eyes, rinse the eyes with running water for 15 minutes and seek medical attention immediately.
- If there has been contact with the skin, wash the contacted area with soap thoroughly and seek medical attention immediately.
- If there has been ingestion, induce vomiting and seek medical attention.

4.1 Fire Situation

Use a FM-200 or Carbon Dioxide (CO₂) fire extinguishers to extinguish the fire if there is a fire in the area where the battery pack is installed. Wear a gas mask and avoid inhaling toxic gases and harmful substances produced by the fire.

5. TRANSPORTATION

5.1 Regulations for the transport of battery modules

It is necessary to comply with the relevant regulations and provisions on roads for shipping lithium-ion products in the corresponding countries.



- Smoking is prohibited in the vehicle during transportation or in the vicinity during loading and unloading



- The dangerous goods transport vehicles shall meet relevant regulations concerning road transportation and shall be equipped with two tested CO₂ fire extinguishers.



- It is forbidden for the freight forwarder to open the outer package of the battery module. Use only approved lifting equipment to move the battery cabinet system. Use only the hanging lug on the top of the battery cabinet as the connection point. When lifting, the angle of the sling must be at least 60°.



- The battery energy storage system can be damaged, if not properly transported. The battery module can only be transported vertically. Note that these parts may be top-heavy. Failure to follow this instruction may result in damage to the part.



- If possible, do not remove the transport packaging before arrival at the installation site. Before removing the transport protector, check if the transport packaging is damaged, and check the impact indicator on the outer packaging of the battery converter. If the impact indicator is triggered, the possibility of transport damage cannot be ruled out.



- Improper transport of battery modules may cause injury. The single battery module weighs 45kg. It could cause injury if it falls or slips. Use only suitable transport and lifting equipment to ensure safe transport.



- Wear safety shoes to avoid the danger of injury. When transporting the battery rack and battery module, their parts may be crushed due to their heavy weight. Therefore, all persons involved in transportation must wear safety shoes with toe caps. Please observe the safety regulations for transportation at the end customer's site, especially during loading and unloading.



- During transportation and installation of unpacked battery storage cabinets, the risk of injury increases, especially on sharp metal panels. Therefore, all personnel involved in transportation and installation must wear protective gloves.



- Improper vehicle transportation can cause injury. Improper transportation or improper transportation locks may cause the load to slip or overturn, resulting in injury. The cabinet shall be placed vertically to prevent it from sliding in the vehicle, and a fixing belt shall be used.

5.2 Permissible and Impermissible Storage Positions of a Packaged

The battery module can only be transported in an upright position.

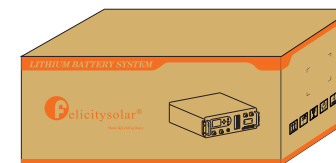
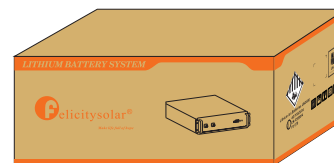

6. STORAGE

- Do not expose battery to open flame.
- Do not place the product under direct sunlight.
- Do not place the product near flammable materials. It may lead to fire or explosion in case of accident.
- Store in a cool and dry place with ample ventilation.
- Store the product on a flat surface.
- Store the product out of reach of children and animals.
- Do not damage the unit by dropping, deforming, impacting, cutting or penetrating with a sharp object. It may cause leakage of electrolyte or fire.
- Do not touch any liquid spilled from the product. There is a risk of electric shock or damage to skin.
- Always handle the battery wearing the insulated gloves.
- Do not step on the product or place any foreign objects on it. This can result in damage
- Do not charge or discharge damaged battery.

7.PRODUCT INFORMATION

1. FLH48100UMG1 is a battery module, it needs to be used with FLH48100UCG1 controller;
2. FLH48100UCG1 is the controller of the whole system, so each system must have four FLH48100UMG1;
3. Our system consists of at least 1 FLH48100UCG1 + 4 FLH48100UMG1 and up to 12 FLH48100UMG1.

7.1 Battery Module Specifications

Model	FLH48100UG1		
Battery Type	LiFePO4		
Nominal Energy	5.12kWh		
Nominal Voltage	51.2V		
Nominal Capacity	100Ah		
Number of Battery Modules	4(Min)	8	12
System Nominal Energy	20.48kWh	40.96kWh	61.44kWh
System Nominal Voltage	204.8V	409.6V	614.4V
System Operating Voltage	192-230.4V	384-460.8V	576-691.2V
Recommend Charge/Discharge current	50		
Max. continuous charge/Discharge current[1]	100A		
Peak Charge/Discharge current(15S)	120A		
Depth of discharge(DOD)	≥95%		
Display type	LED+LCD(Touch)		
IP Rating of Enclosure	IP21		
Working Temperature Range	Charge:0°C~+55°C		
	Discharge:-20°C~+55°C		
Storge Temperature Range	0°C~+35°C		
Humidity	5%~95%		
Altitude	≤2000m		
Cycle Life[2]	≥ 6000 Cycles		
Installation	Rack-Mounting		
Protection	Built-in smart BMS, Breaker, Fuse		
Communication Port	RS485 / CAN		
Warranty Period[3]	10 Year		
Control Module FLH48100UCG1	Product Dimension	482.6x565x150mm	
	Package Dimension	687x562x269mm	
	Product Weight Approximate	10.3kg	
	Package Weight Approximate	16.7kg	

Battery Module FLH48100UMG1	Product Dimension	482.6x565x131mm
	Package Dimension	687x562x250mm
	Product Weight Approximate	41.3kg
	Package Weight Approximate	45kg
	Battery Designation[4]	IFpP/54/150/120/[(1P16S)NS]M/-20+50/95
Rack FLH48100R13G1	Product Dimension	560×590×2137.5mm (13th floor)
	Package Dimension	165×640×2142mm
	Product Weight Approximate	62kg
	Package Weight Approximate	69.5kg
Rack FLH48100R9G1	Product Dimension	560×590×1565.5mm (9th floor)
	Package Dimension	168×642×1570mm
	Product Weight Approximate	46kg
	Package Weight Approximate	52kg(Approx)
[1] Max. continuous charge/discharge current is affected by temperature and SOC.		
[2] Test conditions: 0.2C Charging/Discharging @25°C, 80% DOD.		
[3] Conditions apply, refer to Felicitysolar Warranty policy.		
[4] *N"means the number of battery packs connected series and should not exceed 12.(N≤12)		

Charging method:

When the battery and inverter establish communication, the constant current of 100A is charged until the battery voltage reaches $54.4V * N$, and then the current decreases linearly until the voltage reaches $56.8V * N$ and the current drops to 0A (N is the number of battery packs in series)

7.2 Labels

 Lithium Iron Phosphate Battery	
Model	FLH48100UG1
Nominal Voltage	120-720V
Maximum Continuous Charge/ Discharge Current	100A
Communication	RS485 / CAN
Cycle Life	≥6,000@25°C, 80% DOD
IP Rating of Enclosure	IP21
Working Temperature Range	Charge: 0°C-55 °C
	Discharge: -20°C-55°C

 Lithium Iron Phosphate Battery	
Model	FLH48100UMG1
Nominal Voltage	51.2V
Nominal Capacity	100Ah
Nominal Energy	5.12kWh
Protection Level	IP21
Charging Temperature Range	0-55 °C
Discharging Temperature Range	-20-55°C

 Lithium Iron Phosphate Battery	
Model	FLH48100UG1M4
Nominal Energy	20.48kWh
Nominal Voltage	204.8V
Nominal Capacity	100Ah
Maximum Continuous Charge/ Discharge Current	100A
Communication	RS485 / CAN
Cycle Life	≥6,000@25°C, 80% DOD
IP Rating of Enclosure	IP21
Working Temperature Range	Charge: 0°C-55 °C
	Discharge: -20°C-55°C

 Lithium Iron Phosphate Battery	
Model	FLH48100UG1M5
Nominal Energy	25.6kWh
Nominal Voltage	256V
Nominal Capacity	100Ah
Maximum Continuous Charge/ Discharge Current	100A
Communication	RS485 / CAN
Cycle Life	≥6,000@25°C, 80% DOD
IP Rating of Enclosure	IP21
Working Temperature Range	Charge: 0°C-55 °C
	Discharge: -20°C-55°C

 Lithium Iron Phosphate Battery	
Model	FLH48100UG1M6
Nominal Energy	30.72kWh
Nominal Voltage	307.2V
Nominal Capacity	100Ah
Maximum Continuous Charge/ Discharge Current	100A
Communication	RS485 / CAN
Cycle Life	≥6,000@25°C, 80% DOD
IP Rating of Enclosure	IP21
Working Temperature Range	Charge: 0°C-55 °C
	Discharge: -20°C-55°C

 Lithium Iron Phosphate Battery	
Model	FLH48100UG1M7
Nominal Energy	35.84kWh
Nominal Voltage	358.4V
Nominal Capacity	100Ah
Maximum Continuous Charge/ Discharge Current	100A
Communication	RS485 / CAN
Cycle Life	≥6,000@25°C, 80% DOD
IP Rating of Enclosure	IP21
Working Temperature Range	Charge: 0°C-55 °C
	Discharge: -20°C-55°C

 Lithium Iron Phosphate Battery	
Model	FLH48100UG1M8
Nominal Energy	40.96kWh
Nominal Voltage	409.6V
Nominal Capacity	100Ah
Maximum Continuous Charge/ Discharge Current	100A
Communication	RS485 / CAN
Cycle Life	≥6,000@25°C, 80% DOD
IP Rating of Enclosure	IP21
Working Temperature Range	Charge: 0°C-55 °C
	Discharge: -20°C-55°C

 Lithium Iron Phosphate Battery	
Model	FLH48100UG1M9
Nominal Energy	46.08kWh
Nominal Voltage	460.8V
Nominal Capacity	100Ah
Maximum Continuous Charge/ Discharge Current	100A
Communication	RS485 / CAN
Cycle Life	≥6,000@25°C, 80% DOD
IP Rating of Enclosure	IP21
Working Temperature Range	Charge: 0°C-55 °C
	Discharge: -20°C-55°C

 Lithium Iron Phosphate Battery	
Model	FLH48100UG1M10
Nominal Energy	51.2kWh
Nominal Voltage	512V
Nominal Capacity	100Ah
Maximum Continuous Charge/ Discharge Current	100A
Communication	RS485 / CAN
Cycle Life	≥6,000@25°C, 80% DOD
IP Rating of Enclosure	IP21
Working Temperature Range	Charge: 0°C-55 °C
	Discharge: -20°C-55°C

 Lithium Iron Phosphate Battery	
Model	FLH48100UG1M11
Nominal Energy	56.32kWh
Nominal Voltage	563.2V
Nominal Capacity	100Ah
Maximum Continuous Charge/ Discharge Current	100A
Communication	RS485 / CAN
Cycle Life	≥6,000@25°C, 80% DOD
IP Rating of Enclosure	IP21
Working Temperature Range	Charge: 0°C-55 °C
	Discharge: -20°C-55°C

 Lithium Iron Phosphate Battery	
Model	FLH48100UG1M12
Nominal Energy	61.44kWh
Nominal Voltage	614.4V
Nominal Capacity	100Ah
Maximum Continuous Charge/ Discharge Current	100A
Communication	RS485 / CAN
Cycle Life	≥6,000@25°C, 80% DOD
IP Rating of Enclosure	IP21
Working Temperature Range	Charge: 0°C-55 °C
	Discharge: -20°C-55°C

8. ELECTRICAL CONNECTIONS

8.1 Battery System Features

The batteries have been fitted with multiple protection systems to ensure the safe operation of the system. Some of the protection system includes:

- Inverter interface protection: Over voltage, Over current, External Short Circuit, Reverse Polarity Ground Fault, Over Temp, In rush current.
- Battery Protection: Internal Short Circuit, Over voltage, over current, over temp, Under voltage The battery system contains the following Interface to allow it to connect and operate efficiently.
- LiFePO4: Higher safe performance and longer cycle life.
- Flexible Installation: Rack-Mounting.
- Wide Compatibility: Compatible with leading inverter brands.
- Long Warranty: 10 Years.

8.2 Battery system introduction

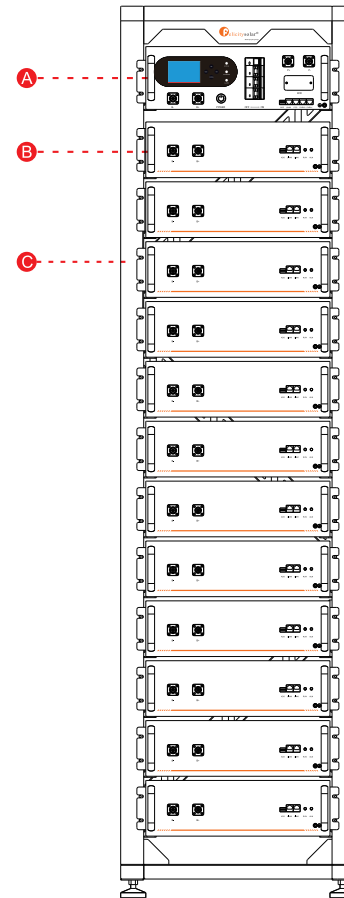

Code	Name	Product Model
A	Control cabinet	FLH48100UCG1
B	Battery box	FLH48100UMG1
C	Rack	*FLH48100R13G1 *FLH48100R9G1

- * FLH48100R13G1:
Built in 1 control module and UP to 12 battery modules
- * FLH48100R9G1:
Built in 1 control module and UP to 8 battery modules

8.3 Electrical Interface Description of Control cabinet

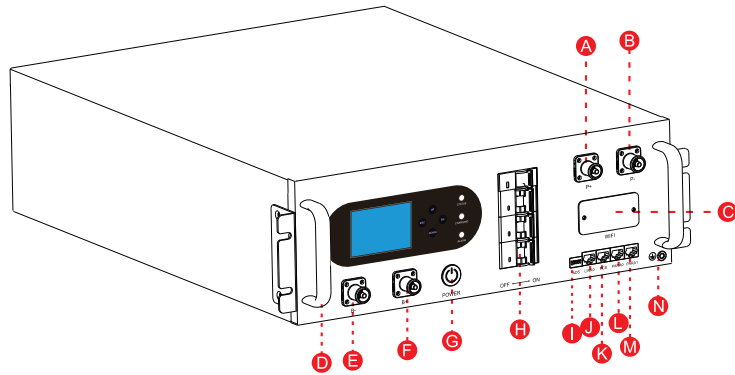

Code	Name	Code	Name
A	PCS +	H	Breaker
B	PCS -	I	ADS
C	WiFi Communication	J	LINK0
D	Handle	K	PCS Communication
E	BAT-	L	Parallel Interface 0
F	BAT+	M	Parallel Interface 1
G	Power Switch	N	Earth wire

8.4 Battery box introduction

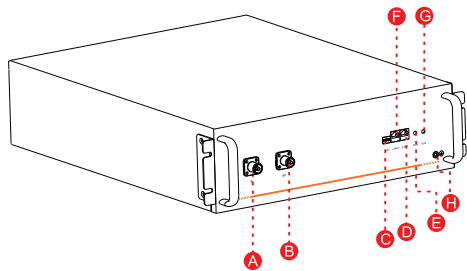

Code	Name
A	BAT-
B	BAT+
C	ADS
D	LINK1
E	Status LED
F	LINK0
G	Alarm LED
H	Earth wire

8.5 Base introduction

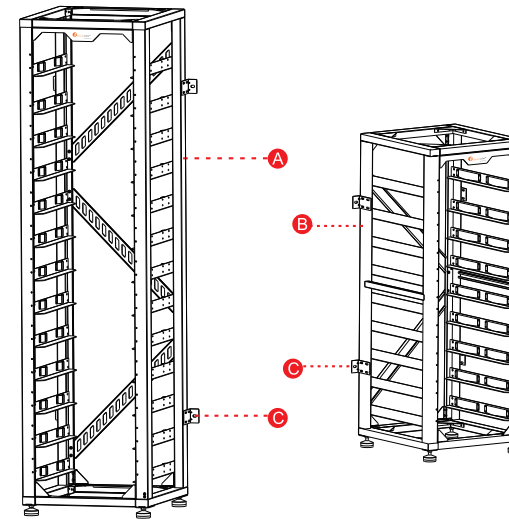

Code	Name
A	Rack(R13)
B	Rack(R9)
C	Fixed trestle

8.6 Switch On/Off

Switch on: close the breaker to the ON block, press and hold Power switch for 2-3 seconds, the battery will perform self-test before output. The LCD will show SOC.

Switch off: close the breaker to the OFF block, the battery will shut down directly.

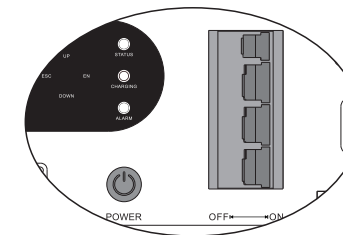

Power ON battery system

9. INSTALLATION











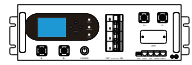

9.1 Tools











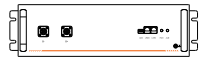







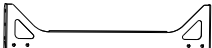

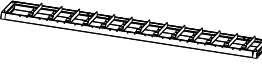
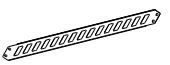
9.2 Items in the package

Packaging information

- The battery system consists of a battery, a control box, and a rack.
- Before unpacking the battery system, check whether the packaging is damaged and check the battery system model. If anything goes wrong, Do not open the packing case, and contact the after-sales service center as soon as possible.
- After unpacking the battery system, check the completeness of the product delivery against the packaging information. If there is any anomaly, please contact the after-sales service center as soon as possible.

FLH48100UCG1			
NO.	DESCRIPTION	QUANTITY	PICTURE
1	High-voltage control box 720V/100A	1	
2	User manual for FLH48100UCG1	1	
3	Warranty card	1	
4	Power Cable 1: 5 meters, 4AWG, allows for charging and discharging up to 110A, used to connect to external PCS+ (red).	1	
5	Power Cable 2: 5 meters, 4AWG, allows for charging and discharging up to 110A, used to connect to external PCS- (black).	1	
6	Power Cable 3: 2 meters, 4AWG, used for serial connection from master control to slave control (black).	1	
7	Power Cable 4: 35 millimeter, 4AWG, used for serial connection from master control to slave control (red).	1	
8	Communication line 1: The communication between the battery pack and the PCS.	1	
9	Communication Line 2: Communication between the battery pack and the Felicity inverter	1	
10	Screw: used for installing control box.	4	
11	Communication Line 4: Used for communication connection between master and slave control	1	
12	Signal Terminal: Used for creating custom communication cables.	2	
13	Ground cable: The 145mm ground cable is used to connect battery pack modules ; The 2m ground cable is used to connect the inverter to the battery ground	2	

14	WiFi module: for installing the WIFI module	1	
FLH48100UMG1			
NO.	DESCRIPTION	QUANTITY	PICTURE
1	5.12kWh battery module	1	
2	User manual for FLH48100UMG1	1	
3	Warranty card	1	
4	Power Cable: used for series connections between battery pack modules.	1	
5	Communication Cable: used for communication connections between battery pack modules.	1	
6	Ground Wire: used for grounding connections between battery pack modules.	1	
7	Screw: used for installing battery pack modules.	4	
FLH48100R13G1			
NO.	DESCRIPTION	QUANTITY	PICTURE
1	LOGO board	1	
2	Cross beam	1	
3	Right side beam	1	
4	Left side beam	1	
5	Left diagonal brace	1	
6	Right diagonal brace	2	

7	Rack fastener	4	
8	BOT Foot Cup	4	
9	Tripod	4	
10	Expansion screw	4	
11	Screw M6×12*66 PCS Screw M5×12*1 PCS	/	
12	Ribbon:Used to fix the power cord	5	

9.3 Product size information

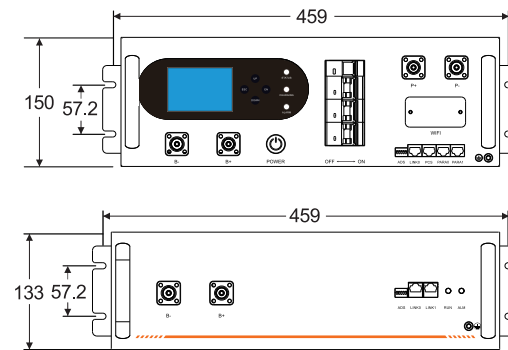
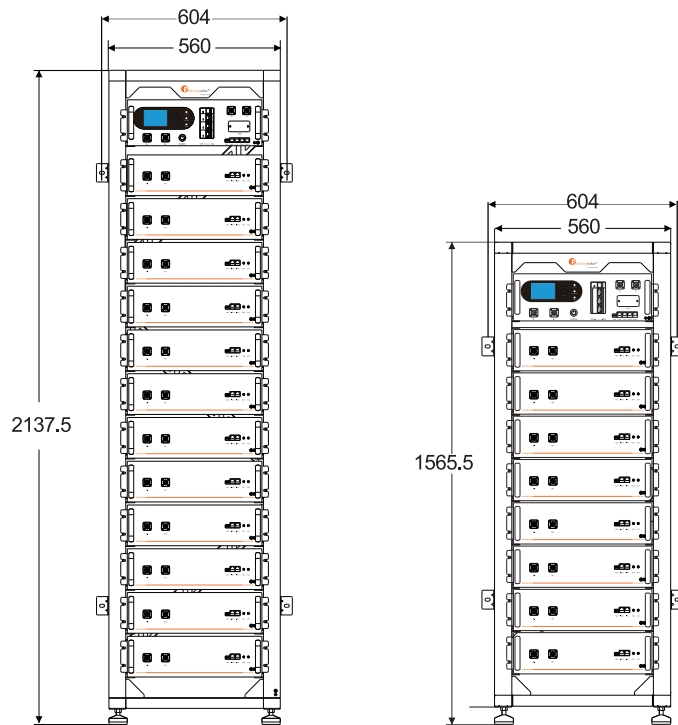

9.4 Floor installation with base

Installation Location Requirements

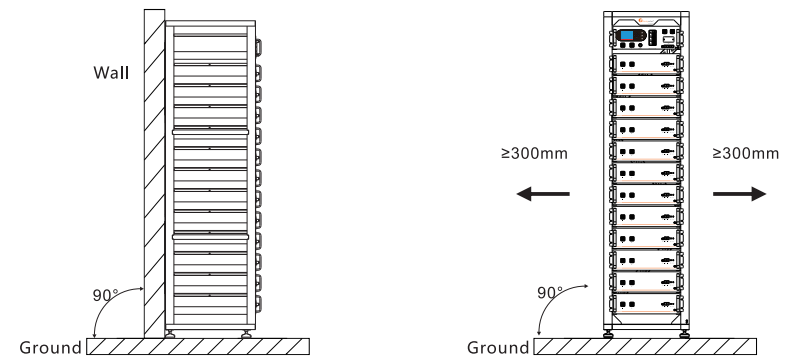
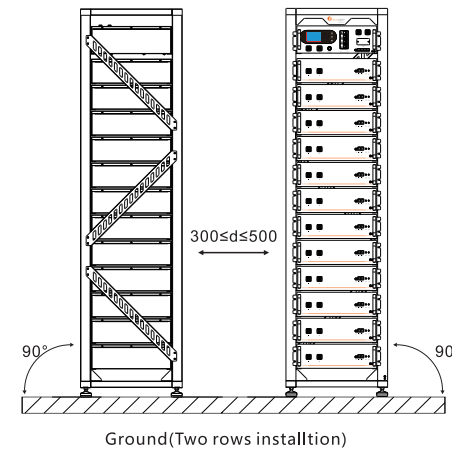

9.5 Install Environment

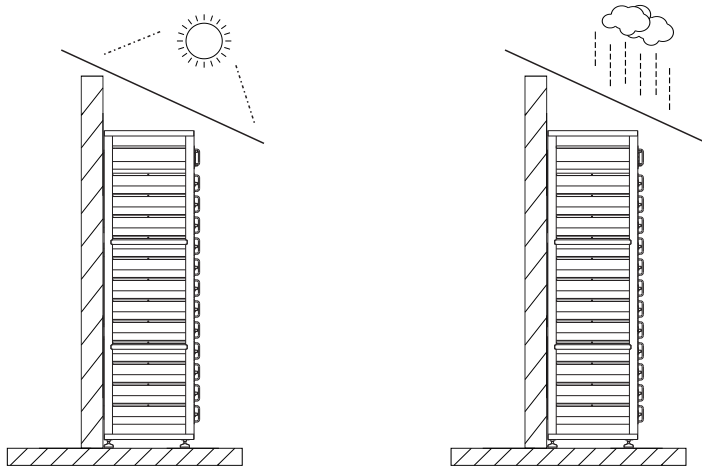

9.6 Installation Procedure

- Step 1: Remove the battery, control box, and frame from the packing case.
 Use a hammer drill to make a frame fixing hole in the wall. (Aperture 10mm, depth 60mm).
- Step 2: Attach the rack to the wall, then install the battery from the bottom to the top, and make sure the battery is secured.
- Step 3: Secure the battery, control box to the rack.

Step 1:

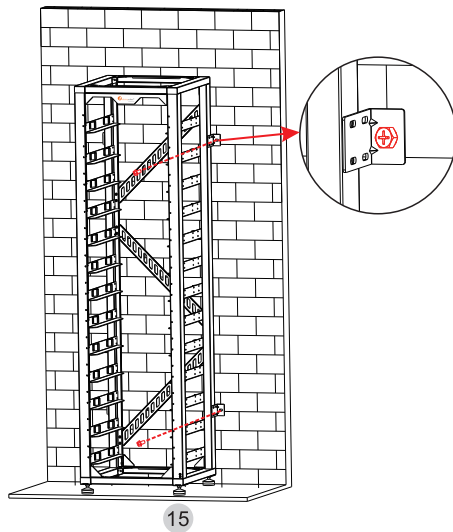

Step 2:

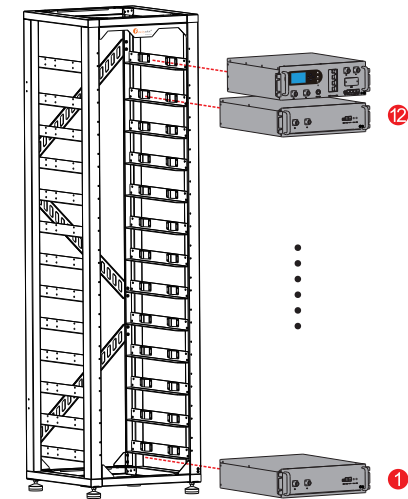

Step 3:

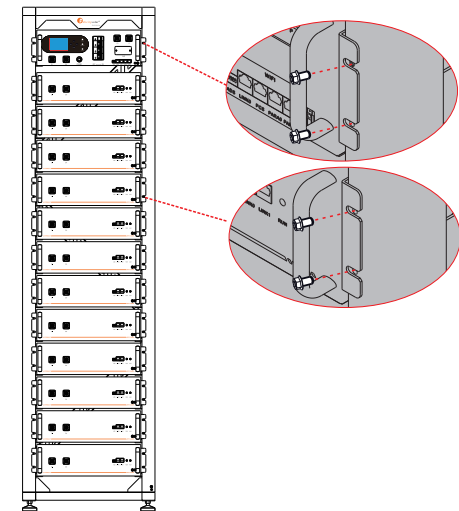

Note:

1. Before installation, check that the ground is flat and has no tilt.
2. Ensure that the rack is against a wall and secured.
3. When placed, it should be pushed inward from the bottom up and from the direction of the arrow.
4. When placing the battery, ensure that the battery is pushed to the bottom.
5. Fasten the battery with the accessory screws. Be careful that the battery falls down.
6. After securing the battery, insert the power cable.

9.7 Wiring procedure

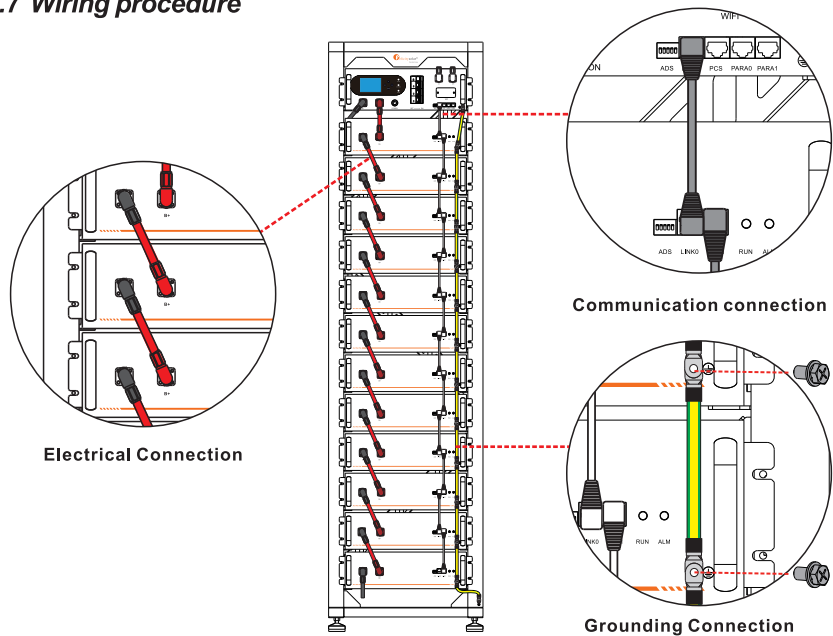

Note:

- When installing equipment, the protective ground wire must be installed first;
When removing the equipment, the protective ground wire must be removed finally.
- Screw compression torque 5N.
- The control box is connected to the ground wire of the base.

9.8 Terminal Connection

Power terminal

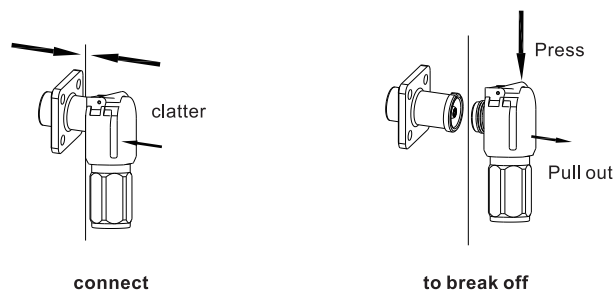

Note: Press the position indicated in the figure above before disconnecting the power terminal.

9.9 System Wiring Schematic

9.9-1 Matching side inverter IVGM50KHP3G1

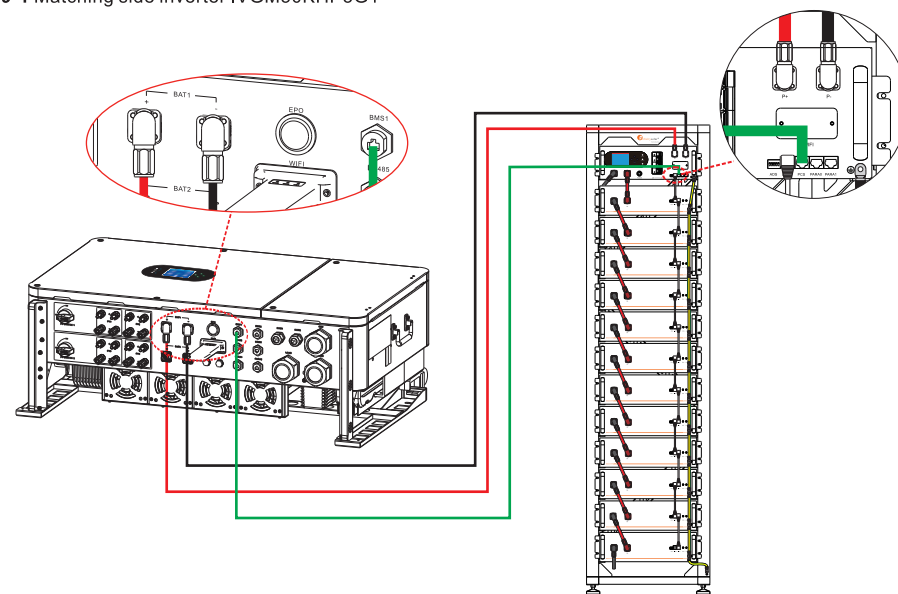

9.9-2 Description for Communication port

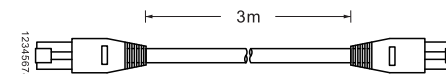

PCS Port Pin Definition

Pin	Function Definitions	Function Declaration
1	NC	NC
2	NC	NC
3	NC	NC
4	CAN-H	Communication between the battery pack and the inverter through the CAN port
5	CAN-L	
6	CAN-GND	CAN-GND
7	RS485-A	Communication between the battery pack and the inverter through the RS485 port
8	RS485-B	

9.10 DIP Switch

Adjust each battery pack dialer from left to right according to the diagram below (from top to bottom)

No.of BAT	1	2	3	4	5	6	7	8	9	10	11	12
1PCS	1,5 ON											
2PCS	1,5 ON	2,5 ON										
3PCS	1,5 ON	2 ON	1,2,5ON									
4PCS	1,5 ON	2 ON	1,2 ON	3,5ON								
5PCS	1,5 ON	2 ON	1,2 ON	3 ON	1,3,5ON							
6PCS	1,5 ON	2 ON	1,2 ON	3 ON	1,3 ON	2,3,5ON						
7PCS	1,5 ON	2 ON	1,2 ON	3 ON	1,3 ON	2,3 ON	1,2,3,5ON					
8PCS	1,5 ON	2 ON	1,2 ON	3 ON	1,3 ON	2,3 ON	1,2,3 ON	4,5ON				
9PCS	1,5 ON	2 ON	1,2 ON	3 ON	1,3 ON	2,3 ON	1,2,3 ON	4 ON	1,4,5ON			
10PCS	1,5 ON	2 ON	1,2 ON	3 ON	1,3 ON	2,3 ON	1,2,3 ON	4 ON	1,4 ON	2,4,5ON		
11PCS	1,5 ON	2 ON	1,2 ON	3 ON	1,3 ON	2,3 ON	1,2,3 ON	4 ON	1,4 ON	2,4 ON	1,2,4,5ON	
12PCS	1,5 ON	2 ON	1,2 ON	3 ON	1,3 ON	2,3 ON	1,2,3 ON	4 ON	1,4 ON	2,4 ON	1,2,4,ON	3,4,5ON

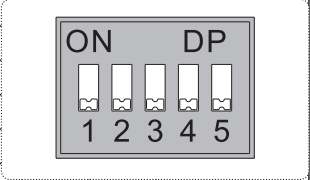

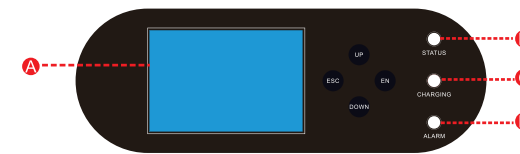

10. LCD DISPLAY ICONS



OBJECT	NAME	DESCRIPTION
A	LCD touch screen	Display the information of the battery.
B	Status LED	Indicates the operating status of the battery, which is always on when running normally.
C	Charging LED	Indicates the charging status of the battery, flashing indicates charging.
D	Alarm LED	Indicates the fault status of the battery, which lights up when the fault occurs.
	Function Button	Esc: Return from current interface or function.
		Up: Move cursor to upside or increase value.
		Down: Move cursor to downside or decrease value.
		Enter: Confirm the selection.

10.1 Main interface

Battery Information	
	Indicate SOC.
	I Indicates the battery level, with each grid representing 5%.

	When charging, this icon lights up
	This icon lights up to indicate that the battery is waiting to be connected, and there is no output at this time. After entering normal working mode, this icon disappears.

Sum data interface:

This interface displays a summary of battery parallel connection information, including average battery voltage, total battery current, average BMS temperature, number of parallel connections, charging limit voltage, discharging limit voltage, charging limit current, discharging limit current, and fault information. Click "Sum Data" and "Details Data" to switch between summary data or detailed data of parallel batteries

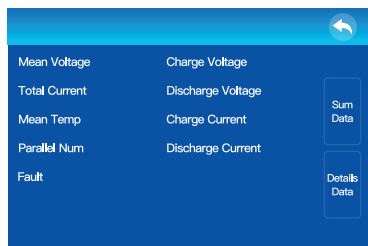

Details data interface:

This interface displays a summary of battery parallel connection information, including average battery voltage, total battery current, average BMS temperature, number of parallel connections, charging limit voltage, discharging limit voltage, charging limit current, discharging limit current, and fault information. Click "Sum Data" and "Details Data" to switch between summary data or detailed data of parallel batteries

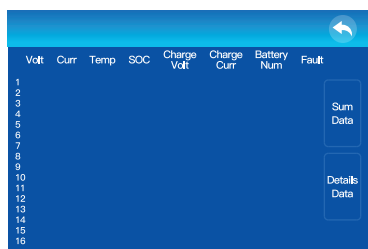

Details data interface:

This interface displays detailed information about parallel batteries, including minimum cell voltage, minimum cell voltage number, maximum cell voltage, maximum cell voltage number, minimum cell temperature, minimum cell temperature number, maximum cell temperature, and maximum cell temperature number

1 to 16 represent the addresses of parallel batteries.

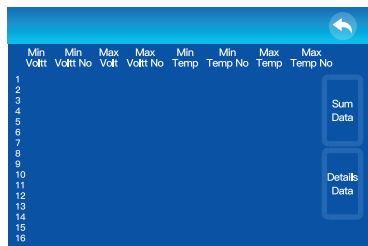

10.2 Fault Code Table

FAULT CODE	EXPLAIN	TREATMENT MEASURE
01	High Battery Voltage	Stop charging
02	Low Battery Voltage	Stop discharging
03	High Cell Voltage	Stop charging
04	Low Cell Voltage	Stop discharging
05	High Charging Current	Reduce charging current
06	High Discharging Current	Reduce discharging current
07	High Bms Temperature	Stop charging and discharging ,wait for the temperature to drop
08	Low Bms Temperature	Wait for temperature rise
09	High Cell Temperature	Stop charging and discharging , wait for the temperature to drop
10	Low Cell Temperature	Wait for temperature rise
11	Afe fault	Restart, if the fault still exists, contact our engineer
12	Soft Start Failed	Restart, if the fault still exists, contact our engineer
13	Slave Communication Failure	Check for poor contact of the communication line
14	Low Output Impedance	Restart, if the fault still exists, contact our engineer
15	Slave Version Fault	Contact our engineer to upgrade the progra
16	Slave Device Version Fault	Contact our engineer to upgrade the program
17	Parallel Fault	1. Please check if the number of parallel battery slave controls is the same 2. Please check if a single unit is installed in a parallel system 3.If this error occurs during parallel installation, please check the wiring. f they are connected correctly, please install them in parallel first and then restart the device. 4.If the problem persists, please contact the installation personnel.
18	Relay Adhesion Fault	Restart, if the fault still exists, contact our engineer

11. CONFIGURE NETWORK

11.1 Download APP

Scan the QR Code on the right side and download the APP.



Fsolar APP

11.2 Connect to Built-in WIFI wireless network

Configure the mobile phone WLAN to connect to the wireless network of the Built-in WIFI

- 1) Run the APP, enter the login page, click the [Setup network] button to enter the network configuration page.

- 2) On the network configuration page, click the [Switch] button to enter the mobile phone WLAN page.

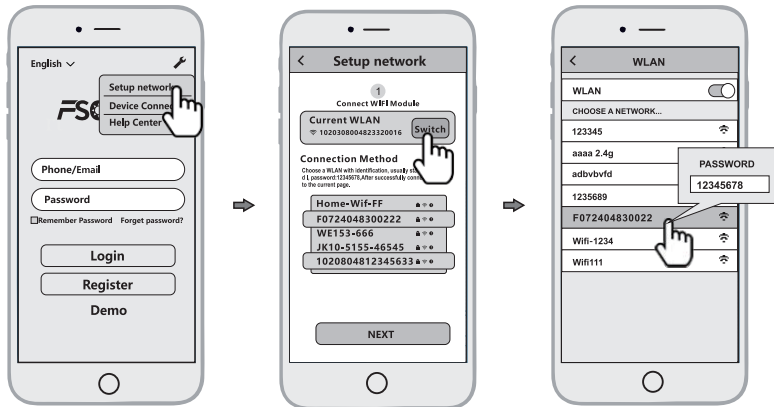

Configure the mobile phone WLAN to connect to the wireless network of the Built-in WIFI.

- 1) Run the APP, enter the login page, click the [Setup network] button to enter the network configuration page.
- 2) On the network configuration page, click the [Switch] button to enter the mobile phone WLAN page.
- 3) On the WLAN page of the mobile phone, find the corresponding wireless network name (SSID) of the Smart WiFi module, starting with F (e.g. Fxxxxxxxxxxxxxxxx, the xxxxxxxxxxxxxxxx is the same as the device serial number). enter the module wireless network password (default password: 12345678), and connect to the wireless network of the Built-in WIFI.

11.3 Configure the network

- 1) After the mobile WLAN is connected to the wireless network of the Built-in WIFI, return to the network configuration page of the APP and click the [NEXT] button to enter the WiFi network page.
- 2) On the WiFi network page, select the router wireless network to which the Built-in WIFI needs to connect, or directly enter the route name, enter the router wireless network password and click the [NEXT] button.

- 3) And then wait for the Built-in WIFI to connect to the router's wireless network, which will take some time.

Then you can use the diagnostic function of the APP or according to the fault appendix to troubleshoot the problem.

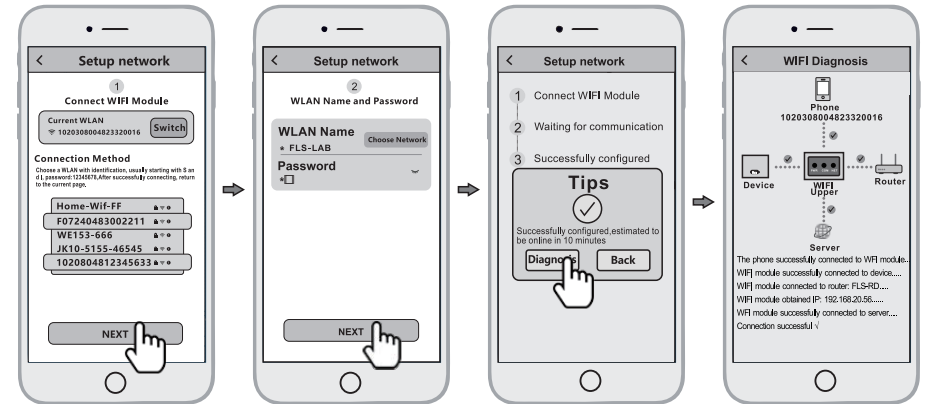

11.4. Create the plant

After the Built-in WIFI is connected to the server, it will transmit the data of the device to the server. And after the plant is created, users can view and manage the device via the APP or web browser.

11.4.1 Manage device via APP

1) Register an account

Run the app, enter the login page, click the [Registration] button, select the role you want to register, enter and fill in the relevant information (optional email/phone number) to register.

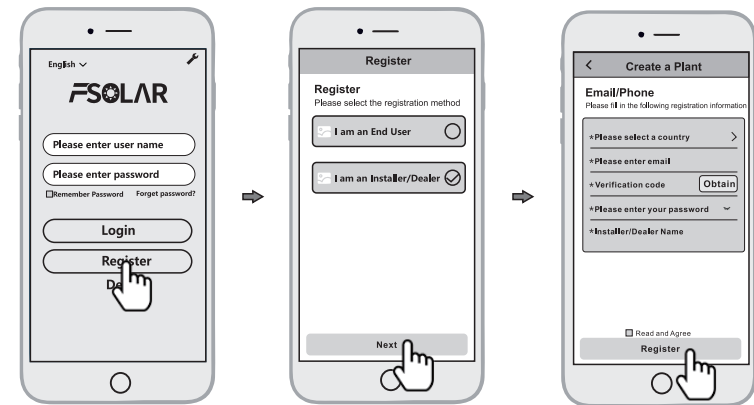

2) New power station construction

- Log in with the newly registered account, enter the homepage, and click on [Create A Plant]

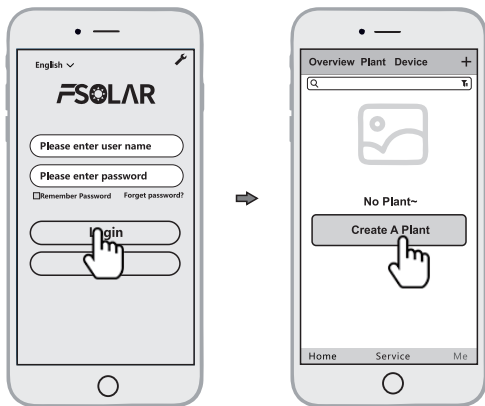

- Fill in the corresponding information and click [OK]
- Click [Add device], click the above icon [scan], align the bar code/two-dimensional code on the side of the inverter or battery pack to scan, or fill in the SN and activation code on the label.

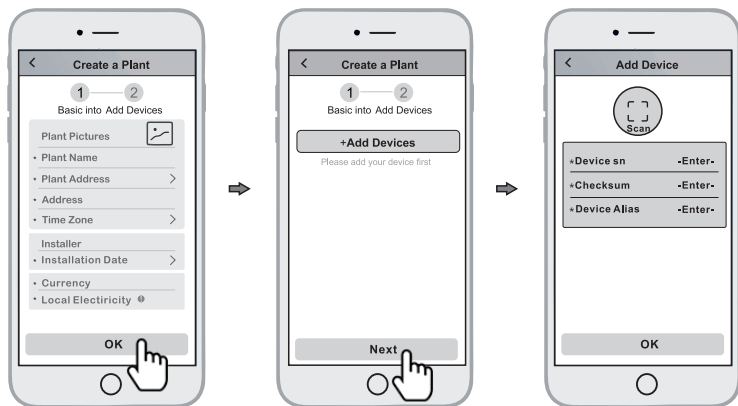

- Manage the device via a web browser, please refer to: <https://shine.felicitysolar.com>

12. WARRANTY

The warranty shall not cover the defects caused by normal wear and tear, inadequate maintenance, handling, storage faulty repair, modifications to the battery or pack by a third party other than Felicitysolar, failure to observe the product specification provided herein or improper use or installation, including but not limited to the following.

Damage during transport or storage.

- Incorrect Installation of battery into pack or maintenance.
- Use of battery pack in appropriate environment.
- Improper, inadequate, or incorrect charge, discharge or production circuit other than stipulated herein.
- Incorrect use or inappropriate use.
- Insufficient ventilation.
- Ignoring applicable safety warnings and instructions.
- Altering or attempted repairs unauthorized personnel.
- In case of force majeure (ex: lightning, storm, flood, fire, earthquake, etc.).
- There are no warranties-implied or express-other than those stipulated herein. Felicitysolar shall not be liable for any consequential or indirect damages arising or in connection with the product specification, battery or pack.

13. TROUBLESHOOTING AND MAINTENANCE

13.1 Maintenance

- 1.Regularly check whether the service environment of the battery meets the requirements, and the installation position should be far away from the heat source.
- 2.In case of one of the following situations, it needs to be charged in time:
 - The battery is often under charged;
 - The battery has been out of use or stored for more than 3 months.
- 3.Regularly check whether the battery and its supporting terminals, connecting cables and indicator lights are normal.

13.2 Troubleshooting

When the red/white LCD on the panel is flashing or normally on, it does not mean that the Battery system is abnormal, it may be just an alarm or protection. Please check the 'Fault Code Table' in chapter 8 for the detailed faulty definition before any trouble-shooting steps. In general, the alarm indication is normal without manual intervention. When the alarm triggering state is removed, Battery system will automatically return to normal use.

- Problem determination based on the following points

- Whether the red light on the FLH48100UCG1 is on;
- Whether the battery can be output voltage or not.
- Whether the battery system can be communicated with inverter;

- Preliminary determination steps

LiFePO4 Battery System for Households Battery system cannot work, when DC switch on and POWER on, the LCD doesn't light up or flash, please consider contact the local distributor.

- The LCD display of FLH48100UCG1 is normal, but it cannot charge and discharge. Observe the display screen of inverter and there is no SOC. Please check whether the CAN communication between LUX-Y-48100HG01 to inverter is well connected. If the connection is good, please replace a CAN communication cable. If the SOC is still not visible on the inverter display screen, please contact the local distributor.
- After the battery system is powered on, if you can see the alarm information on the LCD and inverter display screen at the same time, please contact the local distributor.